

Recommended Panel 1 Cut-out

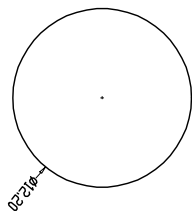

A	1			2			3		
	pin位	2pin	3pin	4pin	5pin	6pin	7pin	8pin	
X 值	1.00	1.00	1.00	1.00	0.80	0.80	0.80	0.80	

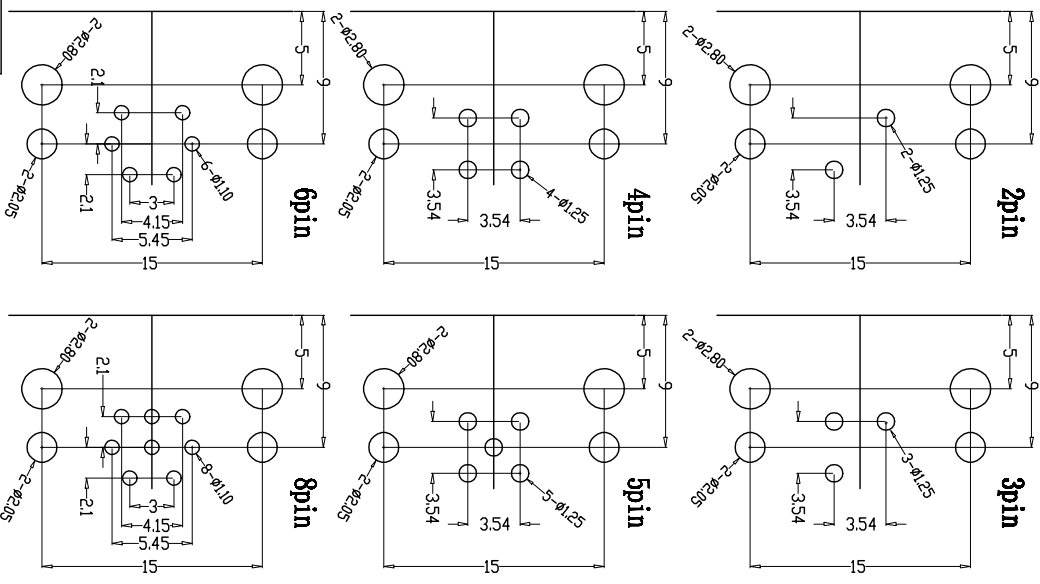
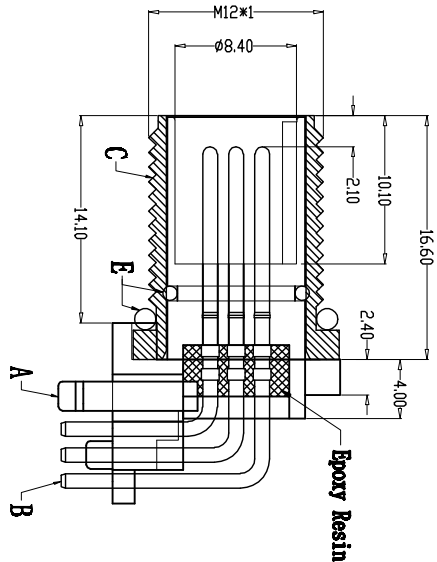
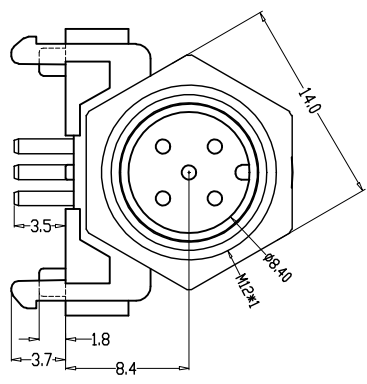
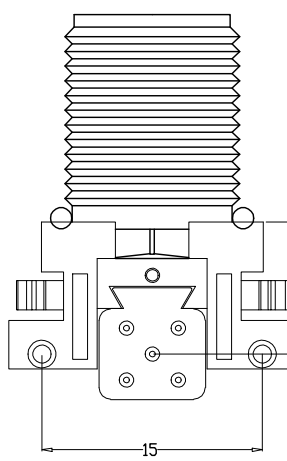
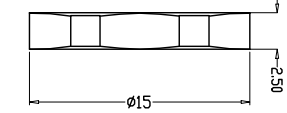
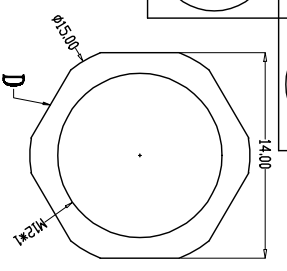
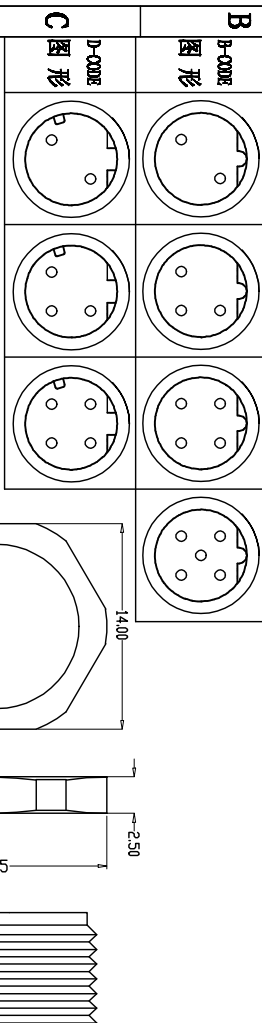

由 Autodesk 教育版产品制作

由 Autodesk 教育版产品制作

PARTS		MATERIALS		TREATMENT		AMOUNT	
A	HOUSING	PAGE6+GF		SPECIFY COLOR		1	
B	CONTACT	BRASS		GOLD PLATED		2*8	
C	OUTER CONTACT	BRASS		NICKEL PLATED		1	
D	NUT	BRASS		NICKEL PLATED		1	
E	O-RING	EPDM		BLACK/RED		1	

Dongguan Changjun Electronics Co., LTD			
东莞市昌骏电子有限公司			
TOLERANCE		TITLE:	
.xxx	±0.05	M12防水28pin公头 板端弯头	
.xx	±0.10	PART NO.:	DRAWING NO.:
.x	±0.20	GR-1120028	GR-1120028
ANGLES	±1°	SCALE:	UNIT: mm
		1:1	SIZE: A4
		DRAWN: Xie Wenjun	CHECK: Long Jichang
		DATE: 2022-09-30	