

A	1			2			3		
	pin位	2pin	3pin	4pin	5pin	6pin	7pin	8pin	
X 值	1.00	1.00	1.00	1.00	1.00	0.80	0.80	0.80	
A-000E 图形									
B-000E 图形									
D-000E 图形									

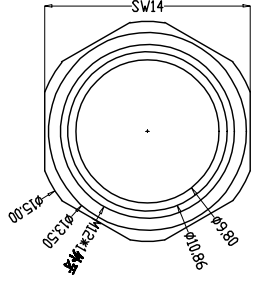

由 Autodesk 教育版产品制作

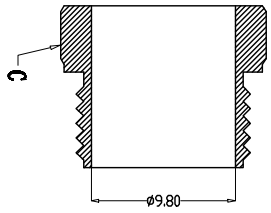
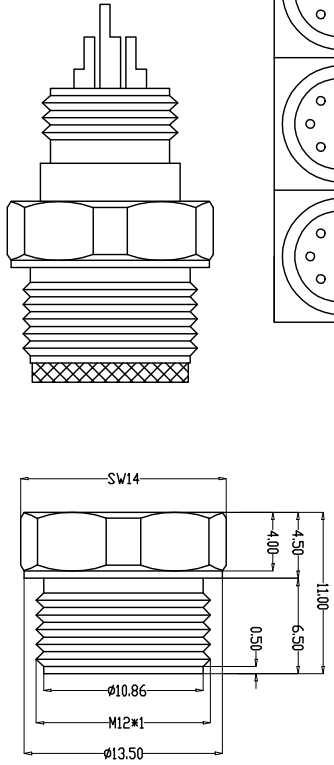
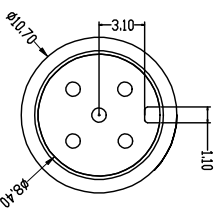
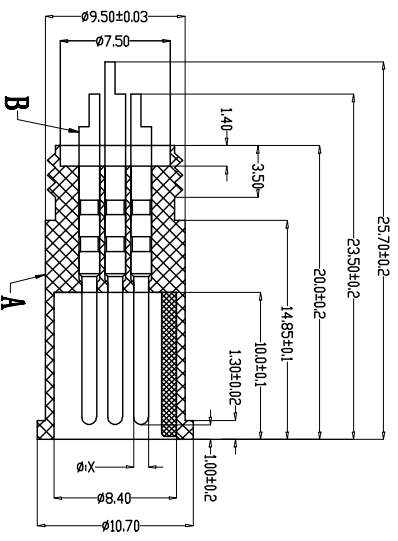
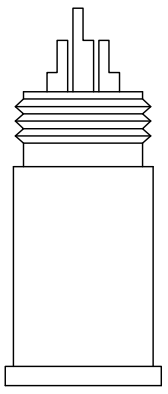
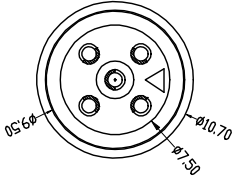

G		PARTS		MATERIALS		TREATMENT		AMOUNT	
		A	HOUSING	PA66+GF	SPECIFY COLOR	GOLD PLATED		1	
		B	CONTACT	BRASS	NICKEL PLATED		2~8		
		C	NUT	BRASS			1		
		D							
		E							
		F							
Engagement force	≤50N	Rated voltage	Rated current	Rated voltage	Rated current	Rated voltage	Rated current	Rated voltage	Rated current
Disengagement force	≥5N	Insulation resistance	Insulation resistance	≥1000V/Ω	≥1000V/Ω	≥1000V/Ω	≥1000V/Ω	≥1000V/Ω	≥1000V/Ω
Mechanical lifespan	≥500	Contact resistance	Contact resistance	≤10mΩ	≤10mΩ	≤10mΩ	≤10mΩ	≤10mΩ	≤10mΩ
IP rating	IP67/IP68	Operation Temperature	Operation Temperature	-40° C~105° C	-40° C~105° C	-40° C~105° C	-40° C~105° C	-40° C~105° C	-40° C~105° C
Flammability	UL94 V-0								

Dongguan Changjun Electronics Co., LTD				东莞市昌骏电子有限公司			
TITLE:				M12防水连接器公头球*11.6寸螺丝			
TOLERANCE				±0.05			
.xxx				±0.10			
.xx				±0.20			
.x				±0.50			
ANGLE				± 1°			
DRAWN:				Xie Wenjun			
CHECK:				Long Jichang			
DATE:				2022-01-05			
PART NO:				CF-H120078			
SHEET:				1 / 1			
SCALE:				1 : 1			
UNIT:				mm			
SIZE:				REV			
DATE:				A/0			