

A	1	2P1N	3P1N4芯3	4P1N	5P1N正方形	6P1N	7P1N	8P1N
	A-000E							
	B-000E							
	D-000E							

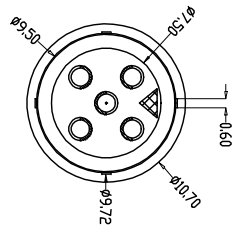
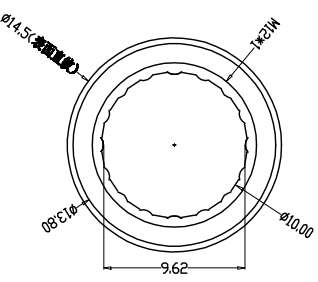
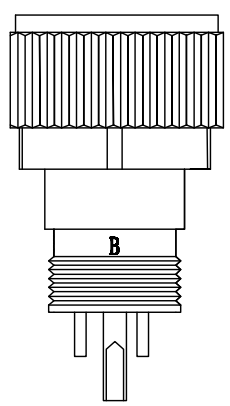
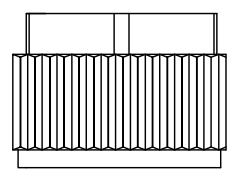
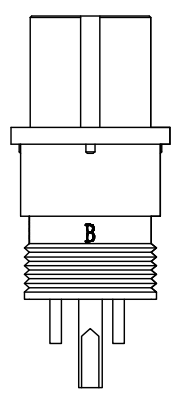
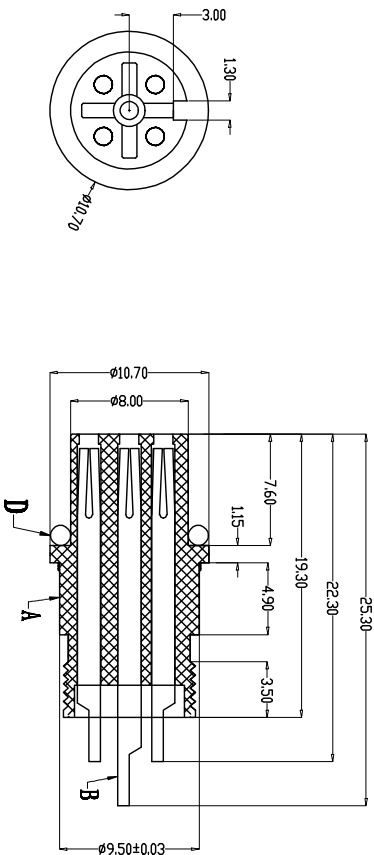
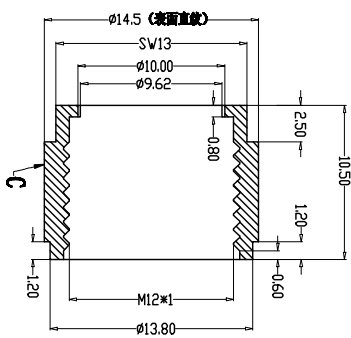
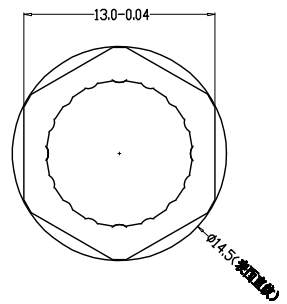

由 Autodesk 教育版产品制作

由 Autodesk 教育版产品制作

G	Engagement force	≤50N	Rated voltage	250VAC
	Disengagement force	≥5N	Rated current	2.5A
	Mechanical lifespan	≥500	Insulation resistance	≥1000MΩ
	IP rating	IP67/IP68	Contact resistance	≤10mΩ
Flammability	UL94 V-0	Operation Temperature	-40° C~105° C	

PARTS		MATERIALS	TREATMENT	AMOUNT
A	HOUSING	PA66+GF	GOLD PLATED	1
B	CONTACT	BRONZE	NICKEL PLATED	2*8
C	NUT	BRASS	NICKEL PLATED	1
D	O-RING	EPDM	BLACK	1
E				
F				

Dongguan Changjun Electronics Co., Ltd
东莞市昌骏电子有限公司

TOLERANCE	±0.05	TITLE	H120069 连接器外壳及接触件
±0.10	±0.20	PART NO.	CS-H120069
±0.30	±0.50	SCALE	1:1
±1°		UNITS	mm
		SIZE	REV
		DATE	A/0
DRAWN	Xie Fenjun	CHECKS	Long Jichang