

A	Pin位	1	2	3	4	5	6	7	8
	A-000E 图形								
	B-000E 图形								
	D-000E 图形								

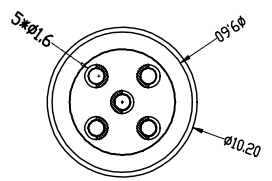
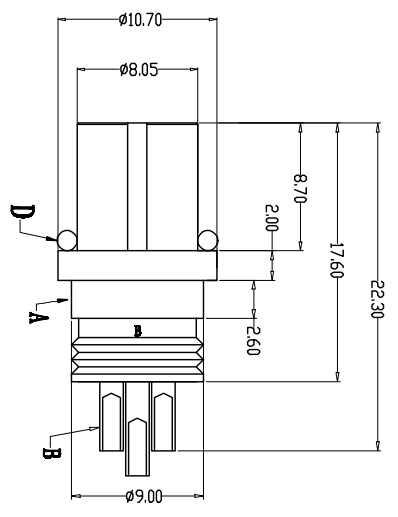
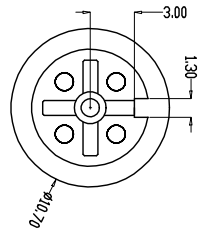
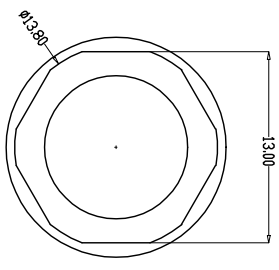
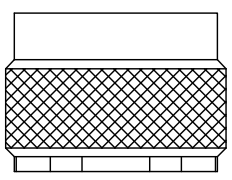
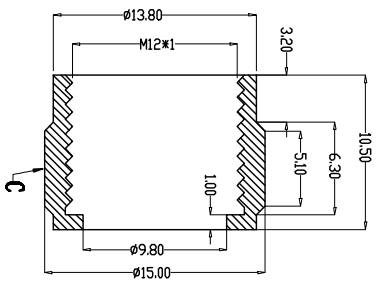
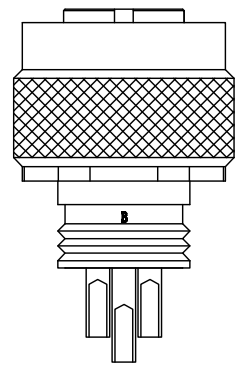

由 Autodesk 教育版产品制作

由 Autodesk 教育版产品制作

PARTS	MATERIALS	TREATMENT	AMOUNT
A HOUSING	PA66+GF	GOLD PLATED	1
B CONTACT	BRONZE		2*8
C NUT	POM	BLACK	1
D O-RING	EPDM	BLACK	1

<b>Dongguan Changjun Electronics Co., LTD</b> <b>东莞市昌骏电子有限公司</b>	
TITLE: H12防水型密封接头(带+10.5L用胶)700000#	DRAWING NO.: CP-1120150
TOLERANCE: .xxx ±0.05, .xx ±0.10, .x ±0.20, x ±0.50	PART NO.: CP-H12CP(3)-F08
ANGLE: ±1°	SCALE: 1:1
DRAWN: Xie Fengjun	CHECKS: Long Jichang
DATE: 2022-01-05	SIZE: REV A/0