

A	pin位	1	2
	图形		

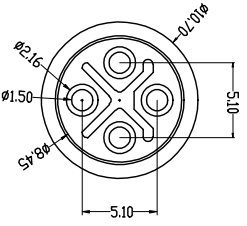
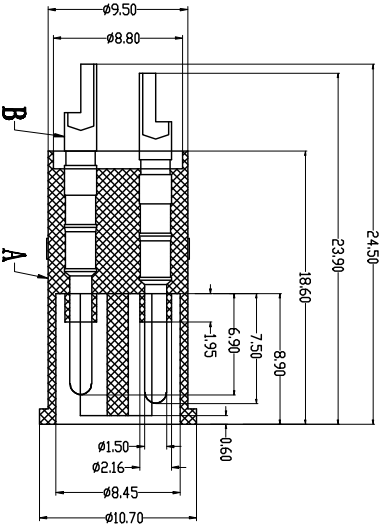
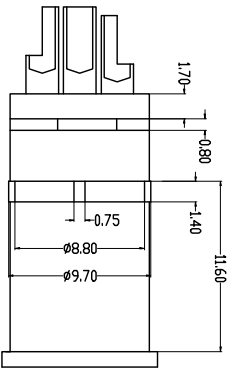
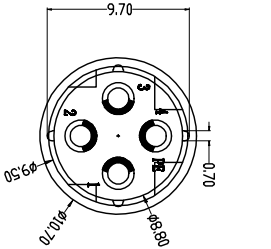
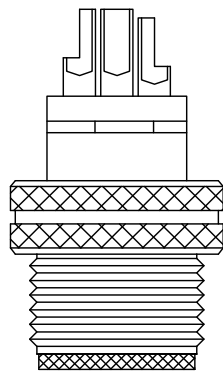
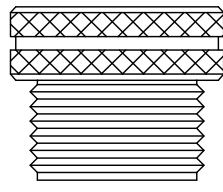
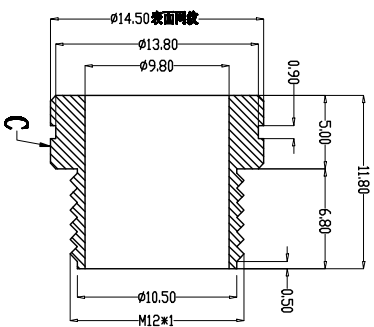

由 Autodesk 教育版产品制作

由 Autodesk 教育版产品制作

PARTS	MATERIALS	TREATMENT	AMOUNT
A HOUSING	PAGE6+GF	SPECIFY COLOR	1
B CONTACT	BRASS	GOLD PLATED	3*4
C NUT	BRASS	NICKEL PLATED	1

Dongguan Changjun Electronics Co., LTD	
东莞市昌骏电子有限公司	
TITLE:	M12防水4Pin接插件公头S-ODM+1L 8L系列板级插件
PART NO.:	CF-H120151
DRIVING NO.:	CF-H120151
DRIVING NO.:	CF-H120151
SCALE:	1:1
UNIT:	mm
SIZE:	REV A/0
DATE:	2022-01-05

Engagement force	Rated voltage	Rated current	Rated power
≤50N	630V	12A	≥10W
Disengagement force	Rated current	Rated power	Rated voltage
≥10N	12A	≥10W	≤50N
Mechanical lifespan	Insulation resistance	Contact resistance	IP rating
≥500	≥1000MΩ	≤10mΩ	IP67/IP68
IP rating	Contact resistance	Flammability	Operation Temperature
IP67/IP68	≤10mΩ	UL94 V-0	-40° C~105° C

TOLERANCE	±0.05
±0.10	
±0.20	
±0.50	
ANGLE	±1°
DRAWN:	Xie Wenjun
CHECK:	Long Jichang

由 Autodesk 教育版产品制作