

A	图形						
B	CODE	A-code	A-code	A-code	B-code	A-code	A-code
	X值	1.00	1.00	1.00	1.00	0.72	0.60

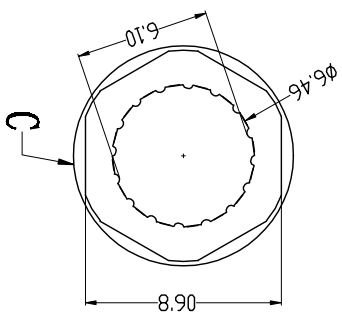
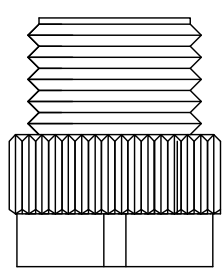
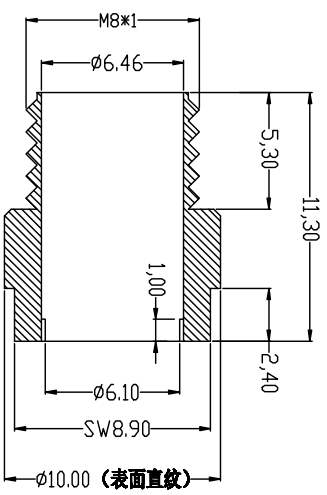
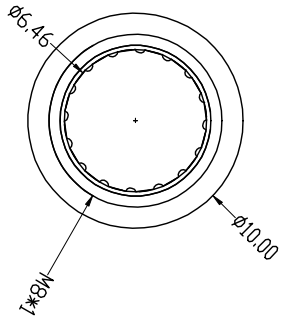
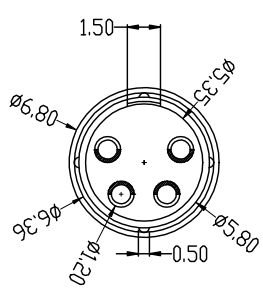
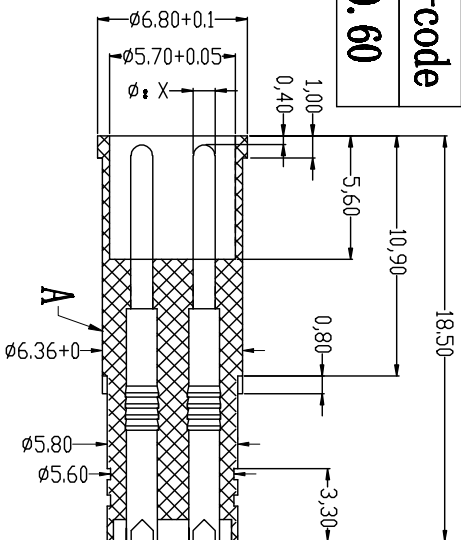
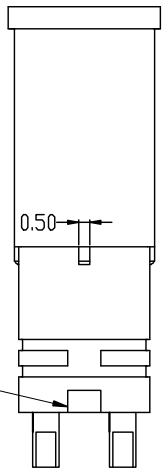
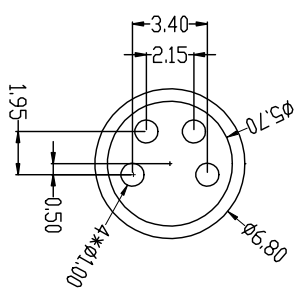

由 Autodesk 教育版产品制作

由 Autodesk 教育版产品制作

Engagement force		≤40N	Rated voltage	2-5pin:60V DC 6-9pin:30V DC
Disengagement force		≥5N	Rated current	2-5pin:4A 6-9pin:2A
Mechanical lifespan		≥500	Insulation resistance	≥1000M Ω
IP rating		IP67/IP68	Contact resistance	≤10m Ω
Flammability		UL94 V-0	Operation Temperature	-40° C~105° C

PARTS	MATERIALS	TREATMENT	AMOUNT
A HOUSING	PA66+GF	GOLD PLATED	1
B CONTACT	BRASS	NICKEL PLATED	2*8
C NUT	BRASS		1

Dongguan Changjun Electronics Co., Ltd 东莞市昌骏电子有限公司	
TITLE:	规格书 02 连接器公头 6+11 孔距 6+6 针间距
PART NO.:	02-000002
DRIVING NO.:	02-000002
SCALE:	1:1
SIZE:	AA
REV:	A/0
DATE:	2022-01-05